

# T100

## AC Dual Balance Charger

### Instruction Manual

[Version 1.0]

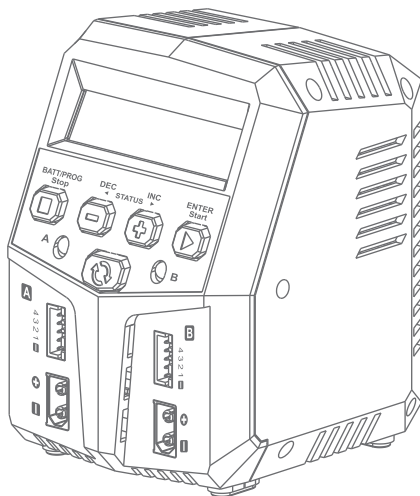

# SKYRC

# TABLE OF CONTENTS

INTRODUCTION .....	01
SPECIAL FEATURES .....	03
WARNING AND SAFETY NOTES .....	05
PROGRAM FLOW CHART .....	08
EXPLANATION OF BUTTONS .....	09
BATTERY & POWER SUPPLY CONNECTIONS .....	10
LITHIUM BATTERY PROGRAM (LIPO/LIFE/LILON/LIHV) .....	11
NIMH/NICD BATTERY PROGRAM .....	14
PB LEAD-ACID BATTERY PROGRAM .....	16
BATTERY MEMORY SET AND CALL OUT .....	19
SYSTEM SETTING .....	21
BATTERY METER .....	23
BATTERY RESISTANCE METER .....	24
WARNING AND ERROR MESSAGE .....	25
THE SET CONTAINS .....	26
SPECIFICATION .....	27
CONFORMITY DECLARATION .....	28
REGULATORY INFORMATION .....	29
COMMONLY USED TERMS .....	30
WARRANTY AND SERVICE .....	31



## WARNING:

- Never leave the charger unattended when charging the battery.
- LiPo batteries pose a severe risk of fire if not properly handled.

Congratulations on your choice of SkyRC T100 AC Dual Balance Charger. This unit is simple to use, but the operation of a sophisticated automatic charger such as SkyRC T100 does require some knowledge on the part of the user. These operating instructions are designed to ensure that you quickly become familiar with its functions. It is therefore important that you read right through the Operating Instructions, Warning and Safety Notes before you attempt to use your new charger for the first time. We hope you have many years of pleasure and success with your new battery charger.

SkyRC T100 is a twin-channel charger with two independent circuits which can charge batteries of varying chemistries (LiPo/LiFe/Lilon/LiHV/NiMH/NiCd/Pb) simultaneously. Its sleek design allows easy front-loading plug-in convenience of balancing and XT60 ports. It is not only compact in size but also powerful in output with maximum 100W charging power and 5A charging current which makes charging more sufficient. With the new AGM and cold charge modes, the user is free to charge their PB and AGM batteries in cold days.

Please BE SURE to read these INSTRUCTIONS, WARNING and SAFETY NOTES before you use the charger for the first time.

It can be dangerous to mis-handle batteries and battery chargers, as there is always a risk of batteries catching fire and exploding.

# INTRODUCTION

Please read this entire operating manual completely and attentively before using this product, as it covers a wide range of information on operating and safety. Or please do use this product in company with a specialist!

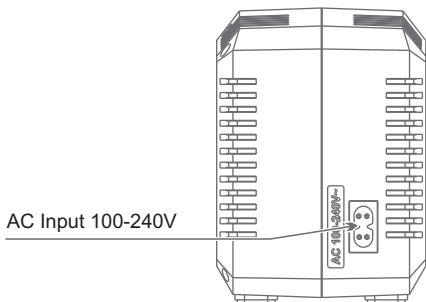
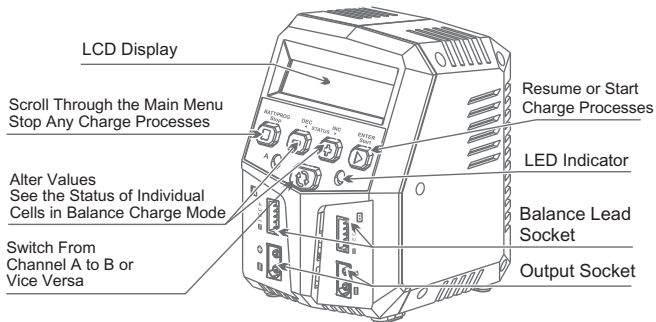

### ***Twin-channel Charger***

SkyRC T100 allows you to plug 2 batteries into one charger simultaneously, and it will intelligently and automatically initiate the charging of 2 batteries at once to their maximum capacity. To top it all, the batteries being charged do not even need to have the same configuration. You can connect different chemistry (NiMH/NiCd/LiPo/LiFe/Lilon/LiHV/Pb) batteries into any of the charging ports.

### ***Optimized Operating Software***

SkyRC T100 features the so-called AUTO function that set the feeding current during the process of charging or discharging. Especially for lithium batteries, it can prevent the overcharging which may lead to an explosion due to the user's fault. It can disconnect the circuit automatically and alarm once detecting any malfunction. All the programs of this product were controlled through two way linkage and communication, to achieve the maximum safety and minimize the trouble. All the settings can be configured by users!

### ***Battery Memory (Data Store/Load)***

The charger can store up to 10 different charge profiles for your convenience. You can keep the data pertaining to program setting of the battery of continuous charging or discharging. Users can call out these data at any time without any special program setting.

### ***AGM and Cold Charge Modes***

With the new AGM and cold charge modes, the user is free to charge their PB and AGM batteries in cold days.

### ***Terminal Voltage Control(TVC)***

The charger allows user to change the end voltage. (for expert user only)

### ***Internal Independent Lithium Battery Balancer***

SkyRC T100 employs an individual-cell-voltage balancer. It isn't necessary to connect an external balancer for balance charging.

### ***Adaptable to Various Type of Lithium Battery***

SkyRC T100 is adaptable to various types of lithium batteries, such as LiPo, Lilon, LiFe and the new LiHV batteries.

### ***Balance and Storage Mode of Lithium Battery***

Function of the two modes differs from each other. "BALANCE CHG" can balance each cells of battery sufficiently during charging, while "STORAGE" has the capacity to control the final battery voltage, which is necessary and helpful for a rarely used battery.

## SPECIAL FEATURES

---

### ***Re-Peak Mode of NiMH/NiCd Battery***

In re-peak charge mode, the charger can peak charge the battery once, twice or three times in a row automatically. This is good for making the battery fully charged.

### ***Delta-peak Sensitivity for NiMH/NiCd***

Delta-peak sensitivity for NiMH/NiCd battery: The automatic charge termination program based on the principle of the Delta-peak voltage detection. When the battery's voltage exceeds the threshold, the process will be terminated automatically.

### ***Battery Meter***

The user can check battery voltage and battery internal resistance.

### ***Capacity Limit***

The charging capacity is always calculated as the charging current multiplied by time. If the charging capacity exceeds the limit, the process will be terminated automatically when you set the maximum value.

### ***Processing Time Limit***

You can also limit the maximum process time to avoid any possible defect.

### ***Battery Icon & Percentage of Charge Display***

It's more intuitive to indicate the current real-time battery power with the battery icon and percentage of charge.

## WARNING AND SAFETY NOTES

**These warnings and safety notes are particularly important. Please follow the instructions for maximum safety; otherwise the charger and the battery can be damaged or at worst it can cause a fire.**

- ❗ Never leave the charger unattended when it is connected to its power supply. If any malfunction is found, TERMINATE THE PROCESS AT ONCE and refer to the operation manual.
- ❗ Keep the charger well away from dust, damp, rain, heat, direct sunshine and vibration. Never drop it.
- ❗ The allowable AC input voltage is 100~240V AC
- ❗ This charger and the battery should be put on a heat-resistant, noninflammable and nonconductive surface. Never place them on a car seat, carpet or similar. Keep all the inflammable volatile materials away from operating area.
- ❗ Make sure you know the specifications of the battery to be charged or to ensure it meets the requirements of this charger. If the program is set up incorrectly, the battery and charger may be damaged. It can cause fire or explosion due to overcharging.

### Standard Battery Parameters

	LiPo	Lilon	LiFe	LiHV	NiCd	NiMH	Pb
Nominal Voltage	3.7V/cell	3.6V/cell	3.3V/cell	3.7V/cell	1.2V/cell	1.2V/cell	2.0V/cell
Max Charge Voltage	4.2V/cell	4.1V/cell	3.6V/cell	4.35V/cell	1.5V/cell	1.5V/cell	2.46V/cell
Storage Voltage	3.8V/cell	3.7V/cell	3.3V/cell	3.85V/cell	n/a	n/a	n/a
Allowable Fast Charge	≦ 1C	≦ 1C	≦ 4C	≦ 1C	1C-2C	1C-2C	≦ 0.4C
Min. Discharge Voltage	3.0-3.3V/cell	2.9-3.2V/cell	2.6-2.9V/cell	3.1-3.4V/cell	0.1-1.1V/cell	0.1-1.1V/cell	1.8V/cell

Be very careful to choose the correct voltage for different types of battery otherwise you may cause damage to the batteries. Incorrect settings could cause the cells to fire or explode.

## WARNING AND SAFETY NOTES

### ❗ Never attempt to charge or the following types of batteries.

A battery pack which consists of different types of cells (including different manufacturers)

A battery that is already fully charged or just slightly discharged.

Non-rechargeable batteries (Explosion hazard).

Batteries that require a different charge technique from NiCd, NiMh, LiPo or Gel cell (Pb, Lead acid).

A faulty or damaged battery.

A battery fitted with an integral charge circuit or a protection circuit.

Batteries installed in a device or which are electrically linked to other components.

Batteries that are not expressly stated by the manufacturer to be suitable for the currents the charger delivers during the charge process.

### ❗ Please bear in mind the following points before commencing charging:

Did you select the appropriate program suitable for the type of battery you are charging?

Did you set up adequate current for charging or discharging?

Have you checked the battery voltage? Lithium battery packs can be wired in parallel and in series, i.e. a 2 cell pack can be 3.7V (in parallel) or 7.4V (in series).

Have you checked that all connections are firm and secure?

Make sure there are no intermittent contacts at any point in the circuit.

### ❗ Charging

During charge process, a specific quantity of electrical energy is fed into the battery. The charge quantity is calculated by multiplying charge current by charge time. The maximum permissible charge current varies depending on the battery type or its performance, and can be found in the information by the battery manufacturer. Only batteries that are expressly stated to be capable of quick-charge are allowed to be charged at rates higher than the standard charge current.

Connect the battery to the terminal of the charger: red is positive and black is negative. Due to the difference between resistance of cable and connector, the charger can not detect resistance of the battery pack, the essential requirement for the charger to work properly is that the charge lead should be of adequate conductor cross-section, and high quality connectors which are normally gold-plated should be fitted to both ends.

Always refer to the manual by battery manufacturer about charging methods, recommended charging current and charging time. Especially, the lithium battery should be charged according the charging instruction provided by the manufacturer strictly.



## WARNING AND SAFETY NOTES

---

Attention should be paid to the connection of lithium battery especially.

Do not attempt to disassemble the battery pack arbitrarily.

Please get highlighted that lithium battery packs can be wired in parallel and in series. In the parallel connection, the battery's capacity is calculated by multiplying single battery capacity by the number of cells with total voltage stay the same. The voltages imbalance may cause fire or explosion. Lithium battery is recommended to charge in series.

# PROGRAM FLOW CHART

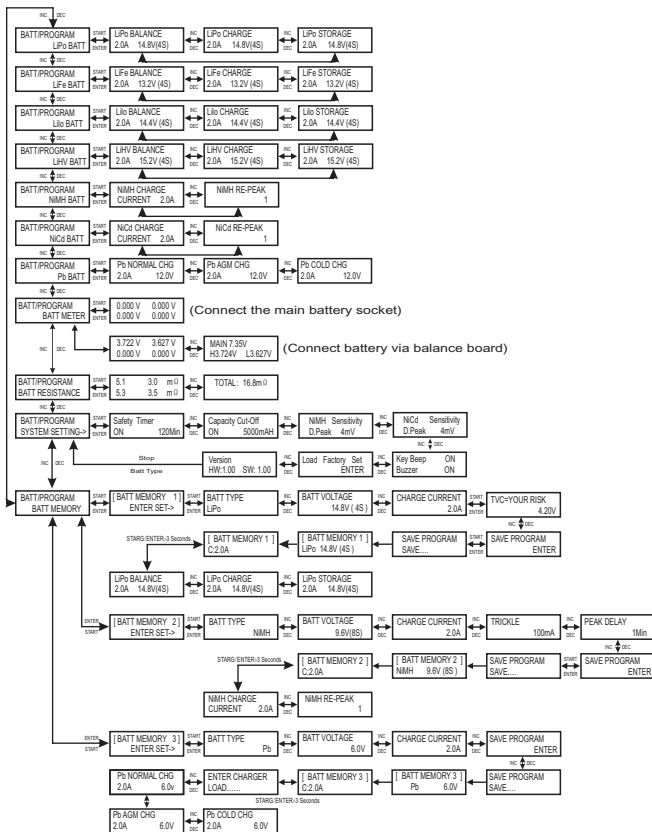

## EXPLANATION OF BUTTONS

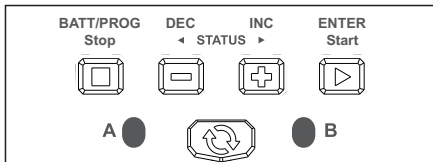

### **BATT PROG / STOP Button:**

It is used to stop the progress or go back to previous step/screen

### **DEC Button:**

It is used to go through the menus and decrease the parameter value

### **INC Button:**

It is used to go through the menus and increase the parameter value

### **ENTER / START Button:**

It is used to enter parameter or store parameter on screen.

### **CHANNEL Button:**

It is used to switch from Channel A to B or vice versa.

When changing a parameter value in the program, press the START/ENTER button to make it blink, then change the value by pressing the DEC and INC button. The value will be stored by repressing the START/ENTER button. If there is a second parameter to edit on the same screen, it will begin blinking after you confirm the first parameter value.

When starting the progress, press and hold the START/ENTER button for 3 seconds. When stopping the progress or go back to previous step/screen, press the BATT PROG/STOP button once.

When you first power the charger on it displays the last processes used. From here you can change the battery type or press enter to change the charge process, charge current rate and/or battery cell count, If you are charging a battery identical to the last one used and want to perform the same process then simply press the start to begin that process.

# BATTERY & POWER SUPPLY CONNECTIONS

Here is the detailed procedure to make the charger work. All the screens and operations will take Li-Po BALANCE CHARGE program for example,

## 1. Connection

### 1). Connecting to power source

It is an AC charger only.

Please insert the AC power cord to the wall socket (100-240V) directly to power it on.

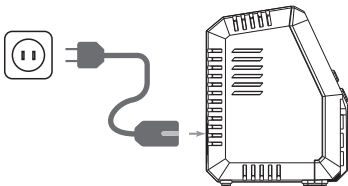

### 2). Connecting the battery

The balance wire attached to the battery must be connected to the charger, with the black wire aligned with the negative marking. Take care to maintain correct polarity. (See the wiring diagram above) This diagram shows the correct way to connect your battery to the SkyRC T100 when charging in the balance charge program mode.

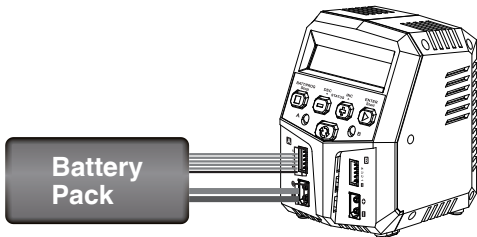

**WARNING!**

**TO AVOID SHORT CIRCUITS, ALWAYS CONNECT THE CHARGE LEADS TO THE CHARGER FIRST, AND THEN TO THE BATTERY. REVERSE THE SEQUENCE WHEN DISCONNECTING THE PACK.**

# LITHIUM BATTERY PROGRAM (LIPO/LIFE/LILON/LIHV)

## 2. Getting started

It is highly recommended to have the flowchart handy while learning to operate this charger. There are two main ways to setup the charger:

(1) Memory profile are available for setting and storing charge parameters for up to 10 different batteries. Once a battery's information is stored into memory, it will be retained until changed again manually. Recalling a battery's memory number makes the charger instantly ready to go!

(2) The other method is by manually setting up the charge process each time. The T100 is capable of the following processes:

The following steps describe how to manual setup the T100

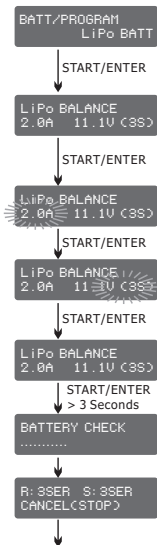

### 3. BATT/PROGRAM Select

Press INC and DEC to go through all the programs and press START/ENTER to enter LiPo BATT Program.

### 4. Mode Select

Press INC and DEC to go through all the modes and press START/ENTER to enter LiPo Balance Charge Mode.

### 5. Battery Setting

Press START/ENTER, the current value will start to blink, press INC and DEC to change the value and press START/ENTER to confirm your setting.

At the same time, the battery cells number will start to blink, press INC and DEC to change the value and press START/ENTER to confirm your setting.

### 6. Program Start

Press and hold START/ENTER for 3 seconds to start the program.

The charger is detecting the battery cell.

R shows the number of cells detected by the charger and S is the number of cells set by you at the previous screen. If both numbers are not identical, press STOP to go back to previous screen to recheck the number of cells of the battery pack before going ahead.

# LITHIUM BATTERY PROGRAM (LIPO/LIFE/LILON/LIHV)

R: 3SER S: 3SER  
CONFIRM(CENTER)

START/ENTER

91% 12.14V  
1.5A 00:50:12

R shows the number of cells detected by the charger and S is the number of cells set by you at the previous screen. If both numbers are identical, press START/ENTER to start charging process.

## 7. Charging Status Monitor

During charge process, The real-time status will be shown on the screen.

A: 25% BAL  
B: NiMH 6.3V CHG

If the user charge two batteries simultaneously, this will be started to display after the twin-channels have been working for ten seconds. And the user is only allowed to back to the working interface that started lastly with START/ENTER and channel switch button.

## VARIOUS INFORMATION DURING THE PROCESS

Press INC or DEC during charging or discharging process allows the user to view a variety of information on the LCD screen.

91% 12.14V  
1.5A 00:50:12

Real-time status: battery icon, percentage of charge or discharge, charge current, battery voltage, elapsed time and capacity.

↓ INC ▶

4070 4060 U  
4110 0 U

Voltage of each cell in the battery pack when the battery is connected with balance lead.

↓ INC ▶

LiPo BALANCE  
2.0A 11.1V (3S)

◀ ↓ DEC

End Voltage  
12.6V(3S)

Final voltage when the program ends.

◀ ⬇ DEC

Safety Timer  
ON 200min

Safety timer ON and duration of time in minutes.

◀ ⬇ DEC

Capacity Cut-Off  
ON 500mAh

Capacity cut-off ON and the setting value of capacity.

# LITHIUM BATTERY PROGRAM (LIPO/LIFE/LILON/LIHV)

## 8. Program Stop

During the charging process, press STOP to stop the charging process.

## 9. Program Complete

When the charging process finishes, an audible sound will be heard.

### Charging Program

Depends on different battery type, the operation programs are different.

Batt Type	Operation Program	Description
LiPo LiHV Lilon LiFe	BALANCE	This mode is for balancing the voltage of lithium-polymer battery cells while charging.
	CHARGE	This charging mode is for charging LiPo/LiHV/LiFe/Lilon battery in normal mode.
	STORAGE	This program is for charging or discharging lithium battery which will not be used for long time.
NiMH NiCd	CHARGE	The charger will charge NiMH and NiCd batteries using the charge current set by the user.
	RE-PEAK	In re-peak charge mode, the charger can peak charge the battery once, twice or three times in a row automatically. This is good for confirming the battery is fully charged, and for checking how well the battery receives fast charges.
Pb	NORMAL CHG	This mode is for charging Pb battery.
	AGM CHG	This mode is for charging AGM battery.
	COLD CHG	This mode is for charging Pb battery in cold days when the temperature is 5°C to -20°C.



**Video  
Tutorial**

Please scan and watch the tutorial video about how to charge LiPo battery in balance mode.



# NIMH/NICD BATTERY PROGRAM

## NiMH/NiCd:

This program is only suitable for charging NiMH/NiCd batteries. The T100 only offer Charge and Re-Peak charge modes for NiMH/NiCd batteries.

## Selecting the Battery Type:

After powering on the T100, press the INC or DEC button repeatedly until you reach the appropriate program for the battery type you wish to charge. For this example we have chosen the "NiMH BATT" or "NiCd BATT" program. Now press the ENTER button to enter the desired program.



WARNING!

**BEFORE YOU BEGIN CHARGING YOUR BATTERY, MAKE SURE YOU ARE CHARGING NIMH/NICD BATTERIES. CHARGING LIPO BATTERY UNDER NIMH/ NICD BATTERY PROGRAM WILL CAUSE FIRE.**

## NiMH/NiCd Charge Mode:

BEFORE YOU BEGIN CHARGING YOUR BATTERY, MAKE SURE YOU HAVE READ AND UNDERSTOOD ALL OF THE WARNINGS AND SAFETY INFORMATION CONTAINED ON PAGES 05-07.

After selecting the correct battery type, if the screen does not read "CHARGE", use the DEC or INC buttons to change it to the "CHARGE" mode.

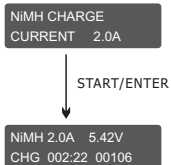

Press the ENTER button and the amp rate value will begin blinking. Use the DEC or INC button to adjust the value to the desired rate. Follow the instructions provided on your battery when setting the charge current.

Press and hold the ENTER button for 3 seconds to start charging.

Once charging has commenced, the charger will display the following real-time information: battery type, charging current, battery voltage, working mode, elapsed time and charged capacity. Once the battery is fully charged, the screen will read "FULL" and the charger will emit a ringing sound. You can press the STOP button at any time during the charging process to stop charging.



## NiMH/NiCd Re-Peak Mode:

Applicable to NiMH and NiCd batteries only, in re-peak mode the charger can peak charge the battery once, twice, or three times in a row automatically. This process is good for confirming that the battery is fully charged and for verifying how well the battery can accept a fast charge. A five-minute cool-down delay occurs after each re-peak charge.

IN RE-PEAK MODE, THE T100 USES THE CHARGE AMPERAGE AND VOLTAGE SETTINGS ENTERED IN CHARGE MODE.

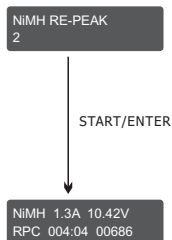

After selecting the correct battery type, use the INC or DEC button to select the "RE-PEAK" mode. Press the START button and the Re-peak cycle number 1 begins to flash on the screen. Use the INC or DEC button to scroll through the cycle count and set a number between 1 and 3.

Press and hold the START button for 3 seconds to start the re-peak process.

Once the Re Peak process has begun, the charger will display the following real-time information: battery type, charging current, battery voltage, Working Mode, elapsed time and charged capacity. Once the Re-P eak proceshas completed, the screen will read "FULL" and the charger will emit a ringing sound. The charger will display the charge/discharge capacity for each cycle. Using the + and - buttons, you can scroll through the history data of each cycle.

# PB LEAD-ACID BATTERY PROGRAM

## Additional NiMH/NiCd Process Information:

During the NiMH/NiCd battery charging process the T100 can display a variety of information. Using the INC or DEC buttons, you can also view the following information:

NiMH Sensitivity  
D.Peak 4mV/CELL

Delta Peak Voltage  
Sensitivity setting

Safety Timer  
ON 120min

Safety timer  
setting

Capacity Cut-Off  
ON 5000mAh

Capacity limit  
setting

## Pb Lead-Acid Battery Program

### Pb (Lead-Acid):

BATT/PROGRAM  
Pb BATT

This program is only suitable for charging 6/12V Pb(lead-acid) batteries which are significantly different from NiMH/NiCd batteries. Pb batteries are suggested to charge with a low current of 0.1C and cannot be used for fast charging. Please follow the instructions provided by the battery manufacturer. The T100 offers the following Pb charge modes: Charge, AGM and COLD.

### Pb Charge Mode:

After selecting the correct battery type, use the INC or DEC button to change it to the "CHARGE" mode.

Press the START button and the amp rate value will begin flashing. Use the INC or DEC buttons to adjust the value to the desired charge rate. The amp rate should be set to 1/10th of capacity. For example, if you are charging a 20Ah battery the charge rate should be set to 2A. Follow the instructions provided on your battery when setting the amp rate.

## PB LEAD-ACID BATTERY PROGRAM

Pb Charge  
1.5A 12.0V(6P)



P-6 1.5A 13.56V  
CHG 002:22 00106

Press the START button again and the nominal battery pack voltage will begin flashing. Use the INC or DEC button to set the voltage and the number of cells.

Press and hold the START button for 3 seconds to start charging.

Once charging has commenced, the charger will display the following real-time information: battery type, charging current, battery voltage, working mode, elapsed time and charged capacity.

When charging is complete, the screen will read "FULL" and the charger will emit a ringing sound.

### Pb AGM Mode:

After selecting the correct battery type, use the INC or DEC button to change it to the "AGM CHARGE" mode.

Press the START button and the amp rate value will begin flashing. Use the INC or DEC buttons to adjust the value to the desired charge rate. The amp rate should be set to 1/10th of capacity. For example, if you are charging a 20Ah battery the charge rate should be set to 2A. Follow the instructions provided on your battery when setting the amp rate.

Pb AGM CHG  
1.5A 12.0V(6P)



P-6 1.5A 13.56V  
CHG 002:22 00106

Press the START button again and the nominal battery pack voltage will begin flashing. Use the INC or DEC button to set the voltage and the number of cells.

Press and hold the START button for 3 seconds to start charging.

Once charging has commenced, the charger will display the following real-time information: battery type, charging current, battery voltage, working mode, elapsed time and charged capacity.

When charging is complete, the screen will read "FULL" and the charger will emit a ringing sound.

## PB LEAD-ACID BATTERY PROGRAM

### Pb Cold Mode:

Pb COLD CHG  
1.5A 12.0V(6P)



Press the START button again and the nominal battery pack voltage will begin flashing. Use the INC or DEC button to set the voltage and the number of cells.

Press and hold the START button for 3 seconds to start charging.

P-6 1.5A 13.56V  
CHG 002:22 00106

Once charging has commenced, the charger will display the following real-time information: battery type, charging current, battery voltage, working mode, elapsed time and charged capacity.

When charging is complete, the screen will read "FULL" and the charger will emit a ringing sound.

# BATTERY MEMORY SET AND CALL OUT

The charger can store up to 10 different charge profiles for your convenience, and the stored profiles can be recalled quickly without having to go through the setup process. When you are willing to alter the parameter value in the program, press START/ENTER to make it blink then change the value with INC or DEC. The value will be stored by pressing START/ENTER once.

Note: All following screen are taking 2S(7.4V) LiPo battery for example.

## 1. Battery Memory Set

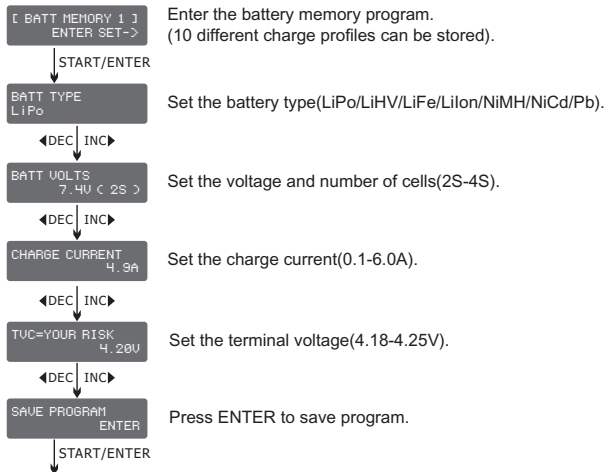

# BATTERY MEMORY SET AND CALL OUT

SAVE PROGRAM  
SAVE .



[ BATT MEMORY 1 ]  
LiPo 7.40 (2S)

Indicate the battery type and battery cell of the saved profile.



[ BATT MEMORY 1 ]  
C: 4.9A

Indicate the charge current of the saved profile.  
Press the START/ENTER for 3 seconds to call out the memory.

START/ENTER  
>3 Seconds



LiPo BALANCE  
4.9A 7.40(2S)

Press START/ENTER for 3 seconds to start the process.



## 2. Battery Memory Call Out

The system will be set to its default parameters when powered on for the first time. The screen displays the following information in sequence and the user can change any given value on each screen.

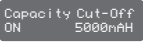
To change a parameter value in the program, press START/ENTER to make that value blink. Next, change the value by pressing INC or DEC. The value will be stored by pressing START/ENTER once.

ITEM	SELECTION	DESCRIPTION
	OFF/ ON (1-720 Min)	When you start a charge process, the integral safety timer automatically starts running at the same time. This is programmed to prevent overcharge the battery if it proves to be faulty, or if the termination circuit cannot detect the battery full. The value for the safety timer should be generous enough to allow a full charge of the battery.
	OFF/ ON (100-50000 mAh)	This program sets the maximum charge capacity that will be supplied to the battery during charge. If the delta peak voltage is not detected nor the safety timer expired by any reason, this feature will automatically stop the process at the selected capacity value.

## SYSTEM SETTING

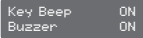
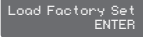
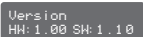
ITEM	SELECTION	DESCRIPTION
	Default: 4mV/Cell 3-15mV/Cell	This program is for NiMH/NiCd battery only. When the charger detects the delta peak value reaches the value you set, the charger will say the battery is fully charged.
		
	OFF/ON	The beep sounds at every time touching the buttons to confirm your action. The beep or melody sounded at various times during operation to alert different mode changes.
		Press and hold the Start/ENTER button to load the factory default settings.
		It indicates the hardware and firmware version.



## BATTERY METER

The user can check battery's total voltage, the highest voltage, the lowest voltage and each cell's voltage.

Please connect the balance wire attached to the battery to the balance socket and the XT60 male connector to the XT60 female connector in front of the charger.

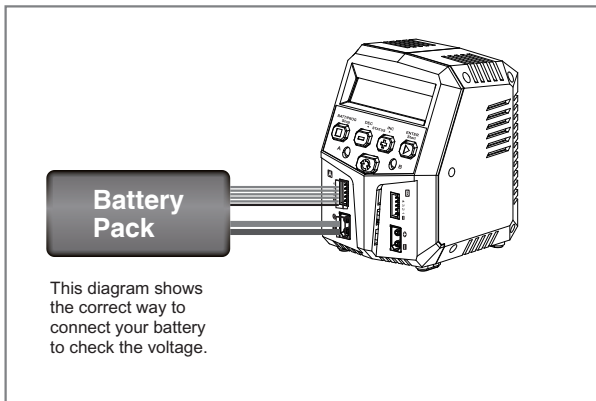

BATT./PROGRAM  
BATT METER

Press the START/ENTER to enter the Lithium Battery Meter program.

START  
ENTER

3.722 U    3.627 U  
0.000 U    0.000 U

The display indicates each cell's voltage.

INC▶

MAIN 16.76V  
H4.200V L4.182V

The display indicates the total voltage, the highest and the lowest voltage.

## BATTERY RESISTANCE METER

The user can check battery's total resistance and each cell's resistance. Please connect the balance wire attached to the battery to the balance socket and the XT60 male connector to the XT60 female connector in front of the charger.

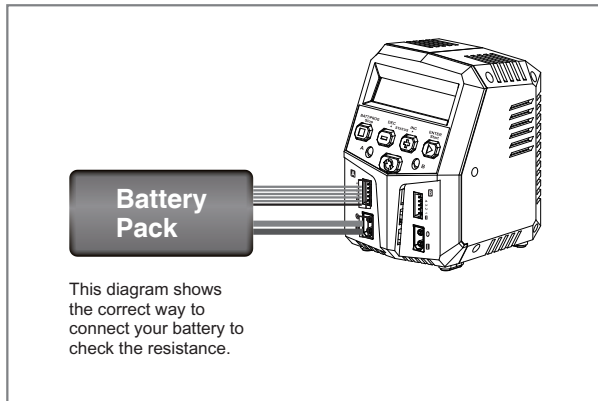

BATT/PROGRAM  
BATT RESISTANCE

Press the START/ENTER to enter the Lithium Battery Resistance program.

Start  
Enter

6.7      12.8 nΩ  
0.0      0.0 nΩ

The display indicates each cell's resistance.

INC

TOTAL: 19.5 nΩ

The display indicates the total resistance.

## WARNING AND ERROR MESSAGE

In case of an error the screen will display the cause of error and emit an audible sound.

REVERSE POLARITY

Incorrect polarity connected.

CONNECTION BREAK

The battery is interrupted.

CONNECT ERROR  
CHECK MAIN PORT

The battery connection is wrong.

BALANCE WIRES  
NOT CONNECTED

The balance wires are not connected while charging in balance mode.

INT. TEMP. TOO HI

The internal temperature of the unit goes too high.

OVER CHARGE  
CAPACITY LIMIT

The battery capacity is more than the maximum capacity which the user sets.

OVER TIME LIMIT

The charging time is longer than the maximum charging time which the user sets.

CONTROL FAIL

Voltage of the battery pack is lower than 5V. This charger can not charge battery whose voltage under 5V.

CELL ERROR

The cell number is wrong.

# THE SET CONTAINS

## THE SET CONTAINS

1. SkyRC T100 Charger
2. Power Cord

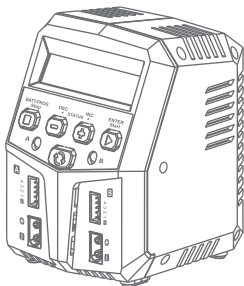

1

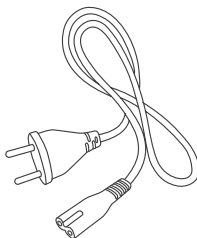

2

- AC Input Voltage : 100-240V
- Display Type: 2x16 LCD
- Case Material: Plastic
- Case Size: 100x90x127mm
- External Port: 2-4S Balance Socket-XH, XT60 Female Connector.
- Delta Peak Detection for NiMH/NiCd: 3-15mV/cell / Default: 4mV/cell
- Charge Voltage: NiMH/NiCd: Delta peak detection
  - LiPo: 4.18-4.25V/cell
  - LiHV: 4.25-4.35V/cell
  - LiFe: 3.58-3.7V/cell
  - Lilon: 4.08-4.2V/cell
- Balance Current: 300mA/cell
- Reading Voltage Range: 0.1-17.4V/cell
- Battery Types/Cells: LiPo/LiHV/LiFe/Lilon: 2-4cells
  - NiMH/NiCd: 6-8cells
  - Pb: 6/12V
- Battery Capacity Range: NiMH/NiCd: 100-50000mAh
  - LiPo/LiHV/LiFe/Lilon: 100-50000mAh
  - Pb: 100-50000mAh
- Charge Current: 0.1A-5.0A
- Safety Timer: 1-170minutes & OFF
- Charge Wattage: 50Wx2 Max
- Balance Cells: 2-4 cells
- Memory: 10 different charge profiles
- Charge Method: CC/CV for Lithium batteries.
  - Delta-peak Sensitivity for NiMH/NiCd batteries.
  - CC/CV and float charge for PB batteries.

# CONFORMITY DECLARATION

SkyRC T100 satisfy all relevant and mandatory EC directives and FCC Part 15 Subpart B

Test Standards	Title	Result
EN 55014-1:2017 Electromagnetic compatibility	Requirements for Household Appliances, electric tools, and similar apparatus –Part 1: Emission	Conform
EN 55014-2:2015 Electromagnetic compatibility	Requirements for Household Appliances, electric tools, and similar apparatus – Part 2: Immunity-Product family standard	Conform
EN 61000-3-2:2014 Electromagnetic compatibility (EMC)	Part 3-2: Limits-Limits for harmonic current emissions (equipment input current up to and including 16 A per phase	Conform
EN 61000-3-3:2013 Electromagnetic compatibility (EMC)	Part 3-3: Limits - Limitation of voltage changes, voltage fluctuations and flicker in public low-voltage supply systems, for equipment with rated current $\leq$ 16 A per phase and not subject to conditional connection	Conform

Test Standards	Title	Result
EN 60335-2-29:2004+A2:2010+A11:2018 to be used in conjunction with EN 60335-1:2012+A11:2014+A13:2017	Safety of household and similar electrical appliances	Conform

Test Standards	Title	Result
IEC 60335-2-29:2002(Fourth Edition) +A1:2004 +A2:2009 for use in conjunction with IEC 60335-1:2010 (Fifth Edition) +A1:2013	Safety of household and similar electrical appliances Particular requirements for battery chargers	Conform

Test Standards	Title	Result
FCC Rules Part 15 Subpart B	Unintentional Radiators	Conform



This symbol means that you must dispose of electrical from the General household waste when it reaches the end of its useful life. Take your charger to your local waste collection point or recycling centre. This applies to all countries of the European Union, and to other European countries with a separate waste collection system.

### FCC Note:

This device complies with Part 15 of the FCC rules. Operation is subject to the following two conditions:

(1) this device may not cause harmful interference, and (2) this device must accept any interference received, including interference that may cause undesired operation.

The manufacturer is not responsible for any radio or TV interference caused by unauthorized modifications or change to this equipment. Such modifications or change could void the user's authority to operate the equipment.

This equipment has been tested and found to comply with the limits for a Class B digital device, pursuant to part 15 of the FCC Rules. These limits are designed to provide reasonable protection against harmful interference in a residential installation. This equipment generates, uses and can radiate radio frequency energy and, if not installed and used in accordance with the instructions, may cause harmful interference to radio communications. However, there is no guarantee that interference will not occur in a particular installation. If this equipment does cause harmful interference to radio or television reception, which can be determined by turning the equipment off and on, the user is encouraged to try to correct the interference by one or more of the following measures:

- Reorient or relocate the receiving antenna.
- Increase the separation between the equipment and receiver.
- Connect the equipment into an outlet on a circuit different from that to which the receiver is connected.
- Consult the dealer or an experienced radio/TV technician for help.

To maintain compliance with FCC's RF exposure guidelines, this equipment should be installed and operated with a minimum distance of 20cm between the radiator and your body.

## COMMONLY USED TERMS

### *Commonly used terms*

**Final charge voltage:** the voltage at which the battery's charge limit (capacity limit) is reached. The charge process switches from a high current to a low maintenance rate (trickle charge) at this point. From this point on further high current charging would cause overheating and eventual terminal damage to the pack.

**Final discharge voltage:** the voltage at which the battery's discharge limit is reached. The chemical composition of the batteries determines the level of this voltage. Below this voltage the battery enters the deep discharge zone. Individual cells within the pack may become reverse polarized in this condition, and this can cause permanent damage.

**A, mA:** unit of measurement relating to charge or discharge current.  $1000 \text{ mA} = 1 \text{ A}$  (A=Ampere, mA=Milliampere)

**Ah, mAh:** unit of measurement for the capacity of a battery (Amperes x time unit; h = hour). If a pack is charged for one hour at a current of 2 A, it has been fed 2 Ah of energy. It receives the same quantity of charge (2 Ah) if it is charged for 4 hours at 0.5 A, or 15 minutes ( $=1/4 \text{ h}$ ) at 8 A.

**'C'-rating:** Capacity is also referred to as the 'C' rating. Some battery suppliers recommend charge and discharge currents based on the battery 'C' rating. A battery's '1C' current is the same number as the battery's rated capacity number, but noted in mA or amps. A 600mAh battery has a 1C current value of 600mA, and a 3C current value of ( $3 \times 600\text{mA}$ ) 1800mA or 1.8A. The 1C current value for a 3200mAh battery would be 3200mA (3.2A).

**Nominal voltage(V):** The nominal voltage of the battery pack can be determined as follows;

-NiCd or NiMH: multiply the total number of cells in the pack by 1.2. A 8-cell pack will have a nominal voltage of 9.6 volts ( $8 \times 1.2$ ).

-LiPo: multiply the total number of cells in the pack by 3.7. A 3-cell LiPo wired in series will have a nominal voltage of 11.1 volts ( $3 \times 3.7$ ).

-Lilo: multiply the total number of cells in the pack by 3.6. A 2-cell Lilo wired in series will have a nominal voltage of 7.2 volts ( $2 \times 3.6$ ).

-LiFe: multiply the total number of cells in the pack by 3.3. A 4-cell Lilo wired in series will have a nominal voltage of 13.2 volts ( $4 \times 3.3$ ).

If the nominal voltage of the battery is not printed on the battery's label, consult your battery manufacturer or supplier. Do not guess the rated voltage of battery.



### ***Liability exclusion***

This charger is designed and approved exclusively for use with the types of battery stated in this Instruction Manual. SkyRC accepts no liability of any kind if the charger is used for any purpose other than that stated.

We are unable to ensure that you follow the instructions supplied with the charger, and we have no control over the methods you employ for using, operating and maintaining the device. For this reason we are obliged to deny all liability for loss, damage or costs which are incurred due to the incompetent or incorrect use and operation of our products, or which are connected with such operation in any way. Unless otherwise prescribed by law, our obligation to pay compensation, regardless of the legal argument employed, is limited to the invoice value of those SkyRC products which were immediately and directly involved in the event in which the damage occurred.

### ***Warranty and service***

We guarantee this product to be free of manufacturing and assembly defects for a period of one year from the time of purchase. The warranty only applies to material or operational defects, which are present at the time of purchase. During that period, we will repair or replace free of service charge for products deemed defective due to those causes.

This warranty is not valid for any damage or subsequent damage arising as a result of misuse, modification or as a result of failure to observe the procedures outlined in this manual.

### **Note:**

1. The warranty service is valid in China only.
2. If you need warranty service overseas, please contact your dealer in the first instance, who is responsible for processing guarantee claims overseas. Due to high shipping cost, complicated custom clearance procedures to send back to China. Please understand SkyRC can't provide warranty service to overseas end user directly.
3. If you have any questions which are not mentioned in the manual, please feel free to send email to [info@skyrc.cn](mailto:info@skyrc.cn)

This content is subject to change.

**Latest version can be downloaded  
from [www.skyrc.com](http://www.skyrc.com)**



If you have any question about this document, please contact  
SkyRC by sending a message to [info@skyrc.cn](mailto:info@skyrc.cn)  
All Rights Reserved.